

Minimizing the Cost of Innovative Nuclear Technology Through Flexibility: The Case of a Demonstration Accelerator-Driven Subcritical Reactor Park

EPRG Working Paper 1018

Cambridge Working Paper in Economics 1037

Michel-Alexandre Cardin, Steven J. Steer, William J. Nuttall, Geoffrey T. Parks, Leonardo V.N. Gonçalves, Richard de Neufville

Abstract Presented is a methodology to analyze the expected Levelised Cost Of Electricity (LCOE) in the face of technology uncertainty for Accelerator-Driven Subcritical Reactors (ADSRs). It shows that flexibility in the design and deployment strategy of an ADSR park demonstrator significantly reduces its expected LCOE. The methodology recognizes in the conceptual design a range of possible technological outcomes for the ADSR accelerator system. It identifies flexibility “on” and “in” the design to modify the future development path in light of such uncertain scenarios. Uncertainty and flexibility are incorporated in the ADSR valuation. The resulting economic assessment is more realistic than typical discounted cash flow analysis that does not consider a range of development outcomes, or the flexibility to change development path.

Keywords accelerator-driven subcritical reactor, real options, flexibility in design, electricity production, economics

JEL Classification D81

Contact macardin@mit.edu
Publication August 2010
Financial Support EPSRC, grant number EP/G009864/1



Minimizing the Cost of Innovative Nuclear Technology Through Flexibility: The Case of a Demonstration Accelerator-Driven Subcritical Reactor Park

Michel-Alexandre Cardin¹

Engineering Systems Division, Massachusetts Institute of Technology, Cambridge, MA 02139, USA.

Steven J. Steer

*ESRC Electricity Policy Research Group and
Department of Engineering, University of Cambridge, Cambridge, CB2 1PZ, UK.*

William J. Nuttall

*ESRC Electricity Policy Research Group and
Department of Engineering, University of Cambridge, Cambridge, CB2 1PZ, UK.*

Geoffrey T. Parks

Department of Engineering, University of Cambridge, Cambridge, CB2 1PZ, UK.

Leonardo V.N. Gonçalves

Department of Engineering, University of Cambridge, Cambridge, CB2 1PZ, UK.

Richard de Neufville

Engineering Systems Division, Massachusetts Institute of Technology, Cambridge, MA 02139, USA.

26 July 2010

▪ Introduction

Thorium-fuelled Accelerator-Driven Subcritical Reactor (ADSR) technology is a promising avenue for transmutation of radioactive wastes (Bowman et al., 1992; Foster, 1974), and for secure, low-emission, and more publicly acceptable power generation (Carminati et al., 1993). It consists of a nuclear reactor core operating subcritically, and a high-power accelerator bombarding a spallation target within the reactor with a particle beam to generate additional neutrons to sustain the chain reaction (Figure 1). This technology offers new potentials for governments concerned with limiting CO₂ emissions, reducing risks associated with nuclear weapons proliferation and geological waste disposal, and sustaining prosperous economic development. In countries with considerable thorium reserves (e.g.

¹ Michel-Alexandre Cardin – macardin@mit.edu

India), it has the potential to capture a non-trivial segment of the growing electricity market. In other countries, it can help diversify the portfolio of low CO₂-emitting technologies.

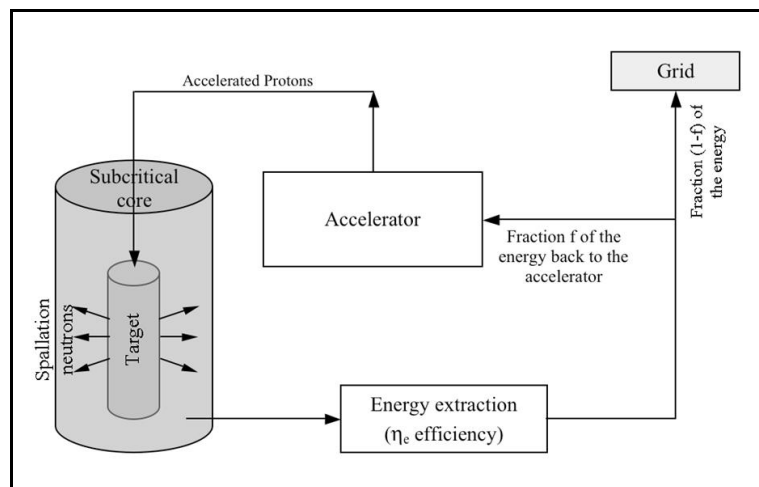

Figure 1: Conceptual representation of an ADSR system for power generation (adapted from Rubbia et al., 1995).

Evaluating the Cost of Uncertain Technology

Developing thorium-fuelled ADSR technology promises to be technically challenging, economically risky, and capital-intensive. Traditional nuclear power technology has high capital cost (Pouret et al., 2009), and requires many years of pre-development, construction, and testing before providing online capacity. Combining it with accelerator technology will require additional capital commitment, and involve significant extra financial uncertainty. Given the high upfront cost and technological uncertainty involved, one needs a realistic picture on expected deployment cost, one that explicitly recognizes this uncertainty.

There is much uncertainty on how technology will develop during the initial deployment phase of a first-of-a-kind ADSR demonstrator. This uncertainty will ultimately affect the Levelised Cost of generating Electricity (LCOE), useful to evaluate cost and economic performance. One concern unique to ADSR technology relates to the reliability of the accelerator producing the particle-beam. If an unplanned shutdown of an accelerator leads to an ADSR shutdown, then costs are incurred due to failing to supply the electricity grid (Steer et al., 2009). Alternatively if unplanned shutdowns are eliminated through spending additional time performing maintenance on the accelerator, there is less time to schedule operation of the accelerator and sell electricity to the grid.

The concept of “effective availability” is introduced here to characterize how an uncertain accelerator technology may develop in the future. Effective availability of an accelerator represents the percentage of time over the year that the accelerator is in operation. It cannot be 100% due to normal expected maintenance activities over the year. For example, if accelerator technology develops well and is reliable (i.e. unplanned shutdowns are infrequent), effective availability can be high because unplanned maintenance is limited. In contrast, effective availability will be low, if accelerator technology is unreliable, causing

many unplanned shutdowns and maintenance periods. Technical details and assumptions are provided in Steer et al. (2010).

Effective availability ultimately determines the capacity factor of the ADSR, which is the main enabler of economic value for the system. The capacity factor is defined as the ratio of actual electricity produced during the year to the total output had the plant operated at full capacity throughout the year. The ADSR can only generate electricity and therefore revenue when both the accelerator and reactor systems are working correctly. Effective availability is an analogous concept to capacity factor, but it relates to the accelerator system because this system cannot in and of itself produce electricity. If the reactor system were to be 100% reliable, then the accelerator system's effective availability and the ADSR capacity factor would be equal. Hence if the accelerator effective availability is high, the ADSR capacity factor can be high, and more electricity can be produced and sold to the grid. If it is low, the ADSR capacity factor is low, and not as much electricity is produced, thus lowering revenues.

ADSRs are expected to maximize economic value through multiple reactors being constructed at the same geographical site. Such a “reactor park” will benefit from reduced operating costs through sharing facilities and additional capital cost savings due to economies of scale, and learning effects (NEA, 2000). However unique to ADSRs and the topic of this paper, it is hypothesized that the operation of multiple reactors is more efficient if accelerators are shared through an integrated network.

Not Considering Uncertainty Leads to Incorrect Cost Assessment

Not recognizing uncertainty in the early conceptual design phase may lead to incorrect and unrealistic economic valuation of technological deployment costs. Thus, estimating LCOE of an ADSR design based on one expert forecast for electricity and fuel prices, construction costs, capacity factor, and beam availability may turn out to be severely incorrect.

There are essentially three reasons for this. First, research has shown that expert forecasts can be biased and incorrect for a number of reasons (Morgan and Henrion, 1990). Hence, it is most likely that exogenous uncertainties like electricity and fuel prices, construction costs, or endogenous ones like capacity factor and beam availability will not turn out as planned for the entire project lifecycle. Second, even in the unlikely event that forecasts are correct, Savage's “Flaw of Averages” (2000) shows that any decision based on the “average” or “most likely” scenario may lead to incorrect results, and bad investment decisions. This is a consequence of Jensen's inequality for non-linear systems, which implies that $E[f(x)] \neq f(E[x])$. In other words, the benefits generated by upside scenarios (e.g. high electricity price or demand) are limited by capacity, such that on average, the effect of low demand, loss-generating scenarios cannot be exactly counterbalanced. The net result is that the expected economic performance is different than when only one central most likely scenario is used for valuation. Third, typical discounted cash flow (DCF) valuation methods do not incorporate the fact that uncertain factors like fuel cost, electricity price, technology, and the regulatory environment will inevitably change over the long

lifecycle of a nuclear project. The LCOE metric used in this study is also subject to this shortcoming: it discounts back to present value cost and revenue projections made over an entire 40+ years lifecycle. Traditional valuation methods assume full commitment at $t = 0$ to a particular deployment path or strategy over the entire lifecycle. For instance, it assumes that plants may be deployed and become operational to generate revenues at specific times. It assumes a particular price of electricity and annual percentage growth, etc. The reality is that things will change along the way, and managers will adapt to keep operating the system in the best available conditions. This reality is not captured in traditional valuation methods (Dixit and Pindyck, 1994; Trigeorgis, 1996). This can significantly affect investment decisions on large-scale technology deployment, as case studies demonstrate in many other industries: aerospace (de Weck et al., 2004), airports (de Neufville and Odoni, 2003; Kwakkel et al., 2010), petroleum (Jablonowski et al., 2008), ports (Taneja et al., 2010), and real estate (Foster and Lee, 2009).

In short, consequences of not recognizing uncertainty may be that:

- The design deployment strategy is sub-optimal as soon as reality departs from the forecast or chosen parameters, either because it cannot easily adapt to reduce exposure to downside conditions (i.e. over capacity investment), or cannot access upside opportunities (i.e. under capacity investment);
- The cost of switching between alternative operating scenarios may be higher if contingencies are not carefully planned ahead of time to ease the switch (Silver and de Weck, 2007); and
- Importantly from a policy perspective, the project may be undervalued, or be more expensive than it is in reality, resulting in an incorrect message to private and public investors about the true potential of a new technology.

Flexibility Can Reduce Costs, But...

Pioneering work in the real options literature shows how managerial flexibility leads to additional economic value, reduced costs, and/or overall better investment decisions (Cox et al., 1979; Dixit and Pindyck, 1994; Myers, 1977; Trigeorgis, 1996). This body of work is among the first to quantify economically the value to adapt flexibly to changing circumstances. It recognizes the ability to limit exposure to downside risks, and plan contingencies to capitalize on upside opportunities.

This literature typically focuses on valuation of real options “on” projects. It considers managerial flexibility on the project as a whole without necessarily requiring technical inputs from designers and engineers. In Trigeorgis’ taxonomy (1996), deferring investment until optimal market conditions are met is an example of a real option “on” a project. Abandoning a project doomed to fail, or investing in Research and Development (R&D) to access future cash flows of a novel technology (Luehrman, 1998) – if it works – can also be categorized as real options “on” projects.

A number of examples show that real options “in” projects also lead to significant value improvements.ⁱ A real option “in” the project is enabled through technical inputs from engineers and designers. In Trigeorgis’ taxonomy, the ability to phase a project, to expand or contract operating scale, and switch production inputs and outputs are examples of real options “in” projects. For instance, de Weck et al. (2004) show that phasing deployment and re-organizing the orbital configuration of communication satellites could have saved up to 30% in investment cost to Iridium and Globalstar in the 1990s. Lin (2009) shows economic value improvement up to 78% through phasing offshore oil platform development and altering production capacity, as compared to an initial, inflexible design.

...It Requires Guidance in the Early Design Phase

There is very little work on integrated methodologies to 1) incorporate the concept of flexibility in standard design and decision-making practice, and 2) evaluate its economic impact to guide large-scale innovative investments. This is because identifying valuable real option opportunities in complex systems is a challenging process. It requires careful analytical considerations in the early conceptual design phase, and not many analytical tools exist to assist designers in doing so. In addition, as outlined by Barman and Nash (2007), the traditional real options methodology used to value flexibility – surveyed below – has suffered bad publicity, being considered too mathematically oriented to serve immediate practical purposes for design and decision-making. Other practical reasons might be that:

There is no “one fits all” solution for implementing flexibility. Each system is different, and is subject to different uncertainty sources. An infinite number of uncertainty sources can affect the performance of systems (e.g. environmental, market-driven, operational, regulatory, technological, etc.). It is difficult to identify important ones to focus the design effort. Equally, a considerable number of flexible strategies can be explored, depending on the system (e.g. phase capacity deployment, alter operating scale, switch product input/output, abandon or temporarily shut down activities, delay investment, etc.). Designers need to identify valuable opportunities, and engineer relevant design variables and parameters to enable flexibility. Furthermore, they may need to negotiate legal and/or financial disposition to enable flexibility.

- Designers operate within institutional, possibly cultural, engineering “silos” and do not consider how other system components might affect the overall economic value of the system. Dong (2002) shows this for the car manufacturing industry system-level knowledge (required to think about real options “in” systems in the early design phase) is not well documented across different systems disciplines. It took Lin (2009) about a year of close collaboration with oil platform engineers to find out about sub-sea tiebacks as a valuable real option. This is not because designers

ⁱ See http://ardent.mit.edu/real_options/Common_course_materials/papers.html for case studies in many industries.

did not know or think the real option would be valuable, rather they were not actively engaged in discussions with sub-surface engineers to consider this design component.

- Designers think they adequately consider uncertainty and risk when they subject a design to a range of scenarios through sensitivity analysis after an initial design is crafted. This approach, however, does not consider uncertainties in the early conceptual phase prior to more detailed design analysis. It does not recognize the power of adapting pro-actively to changing future conditions, and the potential to increase economic value by doing so.
- Engineering focuses predominantly on detailed (exact or high-fidelity) models. Such models are often computationally expensive and cannot be used to explore many design configurations including flexibility and managerial decision rules under a wide range of uncertain scenarios.

A More Realistic Valuation Approach: Real Options

Many authors have applied the real options methodology to value flexibility under typical uncertainty scenarios encountered in the nuclear industry. This methodology augments traditional valuation methods like Net Present Value (NPV) to recognize explicitly the flexibility to adapt as uncertainty unfolds. It is not part, however, of a clear, systematic framework extending standard design and decision-making practice for uncertainty and flexibility. It is concerned mostly with the economic valuation aspect, and not how these opportunities for flexibility are created in the design process.

For example, Pindyck (1993) shows that additional economic value exists when managers recognize the flexibility to abandon construction of a new nuclear plant if technology and cost evolve unfavourably. These uncertainties can only be resolved once the irreversible investment is made, as more information is revealed. Kiriya and Suzuki (2004) assess the value of waiting for optimal market conditions before investing in a new nuclear build (i.e. a deferral real option). They use an approach similar analytically to Pindyck (2000), although using CO₂ emission credit as the driving source of uncertainty. Rothwell (2006) assumes that a portfolio of tradable assets is available – both real and financial – to replicate the cash flows of a new nuclear build in the United States, based on the dynamic programming approach presented by Dixit and Pindyck (1994). Abdelhamid et al. (2009) use a similar approach to evaluate the option to defer investment in the first nuclear plant built in Tunisia. Marreco and Carpio (2006) use a binomial lattice methodology based on the approach by Cox et al. (1979) to value the operational flexibility to switch between nuclear thermoelectric and hydroelectric generation in the Brazilian power system. Siddiqui and Fleten (2008a) value a portfolio of government investments in R&D for a large-scale alternative energy source, mainly nuclear, alongside an existing renewable energy technology. A similar approach is used to assess the value of the flexibility to stage R&D in thorium-fuelled nuclear technology (Siddiqui and Fleten, 2008b), and to value the optimal timing for nuclear waste disposal in deep geological formations (Loubergé et al., 2002).

Main Contribution

The main contribution of this paper is to demonstrate application of an integrated methodology to investigate whether flexibility can reduce the expected deployment cost of an innovative nuclear technology development. The methodology builds upon and extends standard practice for design and decision-making by considering a priori a range of uncertain outcomes affecting those costs, and adequate flexible responses. It provides a framework for assessing the value of flexibility so it can be compared to its acquisition cost.

The remainder of the paper is structured as follows. First, the methodology employed is explained; there then follows an example application to the deployment of a demonstration ADSR reactor park. The paper is concluded by a discussion of the model assumptions and limitations, as well as the findings. Guidance for future work is also provided.

▪ Proposed Methodology

The methodology is based on the four-step process described by Babajide et al. (2009), similar to the one suggested by Walker et al. (2001) for adaptive policy. The perspective is taken of a single profit-driven company involved in constructing the plant, and selling the electricity generated. The hypothesis is that flexibility will improve net economic value by reducing expected LCOE.

Step 1 consists of developing a basic economic model in Excel® to determine a benchmark design and deployment cost. LCOE is the main economic metric, measured in £/MWh. It is directly comparable to the price of electricity – also expressed in £/MWh – to assess profitability of a design. The economic analysis is based on LINear ACcelerator (LINAC) technology. Equivalent analysis using other types of accelerator would be equally valid. LINAC technology is chosen because construction and operating cost data are readily available.

Step 2 focuses on recognizing and characterizing different sources of uncertainty affecting LCOE in the benchmark design configuration. To simplify demonstration, one major source of uncertainty is characterized, quantified, and incorporated in the benchmark economic model.

Step 3 focuses on identifying and suggesting candidate flexible strategies to deal with the uncertainty source from step 2. It also identifies relevant design components to enable the flexibility. These considerations are added to the benchmark economic model. It provides means of investigating different design configurations.

Step 4 makes use of decision analysis – a simplified, more intuitive implementation of dynamic programming than is used in typical real options valuations – to analyze the flexible deployment options emerging from steps 2 and 3. It recommends a deployment strategy using expected LCOE as the decision metric. Other economic metrics are introduced to demonstrate how they may affect decision-making.

▪ Case Application and Results

Step 1: Development of Basic Economic Model

This paper builds on the analysis by Steer et al. (2010), characterizing the technology and economics of a first-of-a-kind ADSR demonstratorⁱⁱ. The benchmark inflexible design in the initial deployment phase has constructed one accelerator and one reactor (1 accelerator/1 reactor configuration), and extends over eight years. For this benchmark model, accelerator technology is assumed to provide 70% effective availability. This implies that the first-of-a-kind ADSR has a slightly lower capacity factor than a typical Generation III nuclear power station (capacity factor of 85%).

This configuration is then expanded to a demonstration reactor park with three reactors and three accelerators (3 accelerators/3 reactors configuration) (see Figure 2). Each accelerator-reactor pair is independent: an accelerator can only transport its beam to one of the reactors. Construction of each ADSR is phased so that no two ADSRs are constructed in parallel. The total declared net capacity of the site (1,800 MWe) is chosen to be comparable with Generation III nuclear site capacity in the United Kingdom (World Nuclear Association, 2009). It is, however, well below the capacity of the U.K.'s largest coal-fired plant, Drax, at 3,960 MWe.

Table 1 shows additional financial assumptions associated with the construction and operation of the demonstration reactor park. Under these assumptions, the LCOE of the benchmark design is £63.66/MWh. Figure 3 shows in a decision treeⁱⁱⁱ format that this is similar to assuming that the central 70% effective availability (EA) estimate arises with probability = 1.00. It implicitly ignores all other technological scenarios – ultimately leading to a range of capacity factors and LCOEs – by setting their probability to 0.

Such simplified assessment, although a necessary starting point for the analysis, is unrealistic. It ignores the possibility that accelerator technology may turn out better during the first-of-a-kind demonstrator phase, thus leading to more electricity production, and lower LCOE. It also ignores the possibility that the technology may be worse, thus leading to less electricity, and higher LCOE. It ignores altogether the possibility of making a different decision after the initial deployment phase, as some technological uncertainty is resolved. In other words, this assessment is typical of traditional economic valuation. It assumes full commitment at the time of the irreversible investment ($t = 0$), and relies on expert forecasts for the main uncertain design variables and parameters.

ⁱⁱ The spreadsheet of the cost model employed for this paper is available here: <http://www.eprg.group.cam.ac.uk/wp-content/uploads/2010/08/CardinModelEPRG1018.xls>

ⁱⁱⁱ By convention, a square node corresponds to a decision point, while a circle corresponds to a “chance”, or uncertainty outcome. The probability (p) of an outcome is written under the outcome branch. The LCOE of each scenario is displayed at the terminal node, with the associated probability of occurrence. TreeAge Pro® is used for decision analysis.

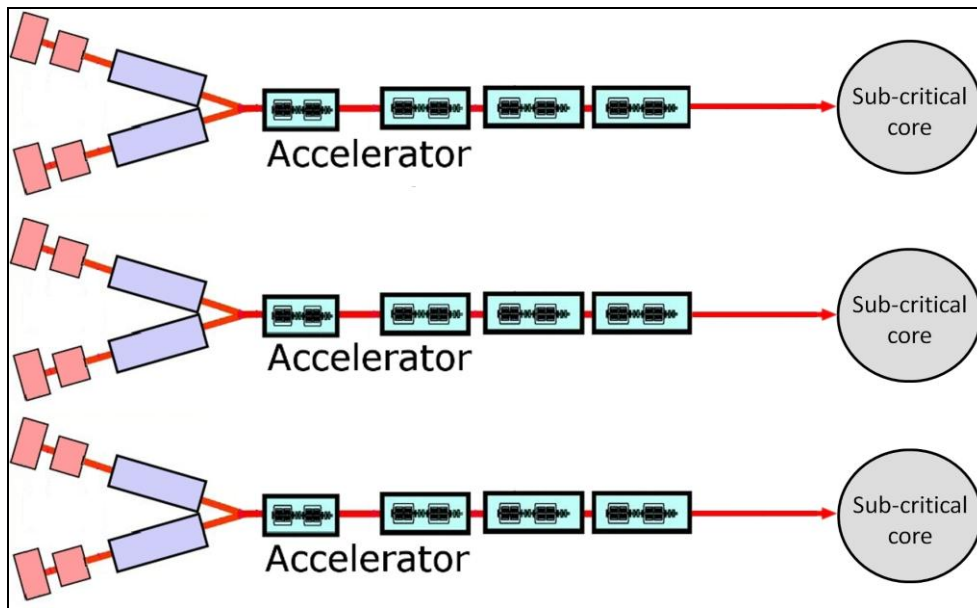

Figure 2: Conceptual representation of the 3 accelerators/3 reactors demonstration park.

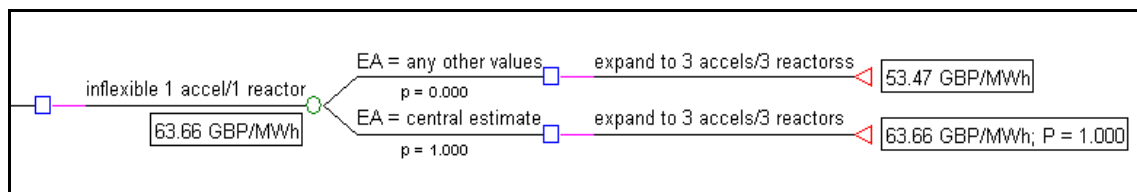

Figure 3: Decision tree assuming probability $p = 1.00$ for the central effective availability (EA) estimate.

Step 2: Uncertainty Recognition and Characterization

There are many sources of uncertainty affecting the expected performance of the system. One is uranium price, an example of exogenous uncertainty. If the price of uranium remains relatively low in the future, this will not favour thorium as an alternative fuel. Another source of uncertainty is whether a strong market for waste disposal will emerge in the future, favouring ADSR systems for transmutation rather than power generation. Future carbon emission credits would also ultimately affect the profitability of ADSR systems. In terms of endogenous design uncertainty, it is not yet clear what the best choice of technology is for coolant, reactor geometry, and spallation target (e.g. with or without window). Delays can also affect overall construction cost, as in most new nuclear builds.

Table 1: List of parameters for the DCF model. These are additional parameters to those described in Steer et al. (2010), which forms the basis of the financial analysis.

Parameter	Assumption	Source/Comment
Initial pre-development costs	£250 million	Identical to the value in Steer et al (2010), this covers all pre-development costs for the whole reactor park.
Declared Net Capacity	600 MWe per reactor, subtract 20 MWe from the reactor park total if it is operating one more accelerator than the number of reactors	
Time required to construct additional reactor and accelerator(s) in phases 2 and 3	6 years	
Timing of construction phase 2	Begins 2 years after initial reactor (phase 1) begins selling electricity	
Timing of construction phase 3	Immediately after phase 2 is completed	
Construction cost of n th -of-kind reactors and accelerators	Identical to the costs of the 1 st -of-a-kind	Cost reductions due to learning effects of the new technology have been neglected.
Operation and Maintenance (O&M) of nuclear reactors	£7.70 /MWh when operating a single reactor, followed by a £3.85 /MWh increase per additional reactor.	Operating reactors in parallel assumes that the O&M cost of each additional reactor is 50% of the base cost.
O&M of accelerators	£34 million per annum when operating a single accelerator, followed by a £17 million per annum increase per additional accelerator.	Operating accelerators in parallel assumes that the O&M cost of each additional accelerator is 50% of the base cost.
Planning for constructing additional accelerators in phases 2 and 3	£20 million is paid during phase 1 for each accelerator that may be constructed later. If the accelerator is constructed, the £20 million is subtracted from the build cost at that time	Taken from Steer et al (2010). The cost of planning for additional reactors is neglected as in all scenarios considered in this paper one reactor is constructed in each construction phase. The uncertainty in the cost of constructing a reactor will be significantly larger than the total cost of planning for their future construction.

Effective availability is the main endogenous source of uncertainty considered in this study. This is because it significantly impacts the potential success of accelerator technology development and reliability, which ultimately determines cost. The study assumes this uncertainty can be resolved significantly during the first-of-a-kind demonstration phase, although clearly not entirely. As seen from the historical development of nuclear power in the United States, the capacity

factor of nuclear power plants has evolved slowly to reach today's value of 85% or more (Moen, 2010).

Three scenarios for effective availability are considered and summarized in Table 2. Scenario 1 depicts an optimistic case where effective availability is 85%. Scenario 2 expects the accelerator system of a single-accelerator ADSR to limit electricity sales to slightly less than the intentions for Generation III nuclear reactors (effective availability of 70%). Scenario 3 investigates a pessimistic view where the effective availability of a reactor driven by a single accelerator is no more than 50%.

Table 2: Summary of three uncertain accelerator technology scenarios considered in this analysis.

Scenario	Effective availability (EA) estimate of a reactor driven by a single accelerator (%)
1 - Optimistic	85
2 - Central	70
3 - Pessimistic	50

In this example, no particular information favours one scenario over another, and all scenarios are considered equally likely ($p = 1/3$ for all scenarios).^{iv} A sensitivity analysis on this particular assumption is given below.

The DCF model is modified to enable variations in the effective availability parameter. The decision tree in Figure 4 shows the LCOE under each scenario, leading to an expected LCOE ($E[LCOE]$) of £68.09/MWh for the benchmark design. Figure 4 makes clear that the deterministic benchmark assessment is only one of several possible technology development scenarios. It also shows that $E[LCOE]$ differs and is actually more expensive than the benchmark assessment (£63.66/MWh).

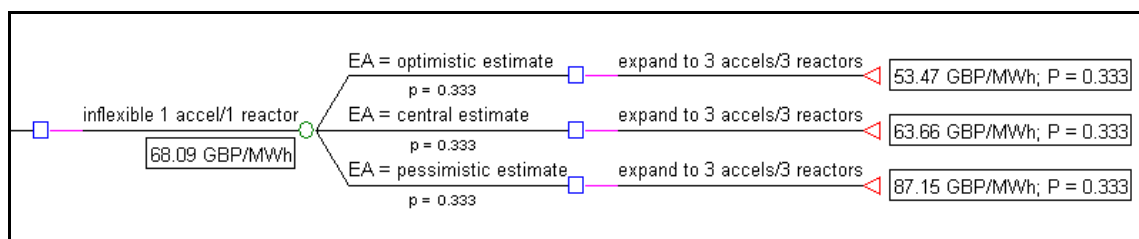

Figure 4: Decision tree for the benchmark design recognizing uncertainty in accelerator reliability.

Figure 5 shows a Cumulative Mass Function (CMF) – also called “target curve” by de Neufville and Scholtes (2010) – for the benchmark design with and without uncertainty recognition. This graphical representation is helpful for decision-makers to identify the range of possible outcomes a particular design may

^{iv} Other assumptions can be used in the framework for probability distributions. The example analysis below would then give rise to another valuation, and potentially different design choices.

produce. It changes the design paradigm from using one LCOE for decision-making (as in step 1) to a range of probabilistic outcomes. For example, it shows there is a one third probability of obtaining a target LCOE between £53.47/MWh and £63.66/MWh. This quantifies the upside opportunities this kind of design may provide. Similarly, there is a one third probability of obtaining a target LCOE between £63.66/MWh and £87.15/MWh, which characterizes downside situations. $E[LCOE]$ is also shown as a vertical dashed line. For reference, the benchmark assessment in step 1 is shown as a solid vertical line.

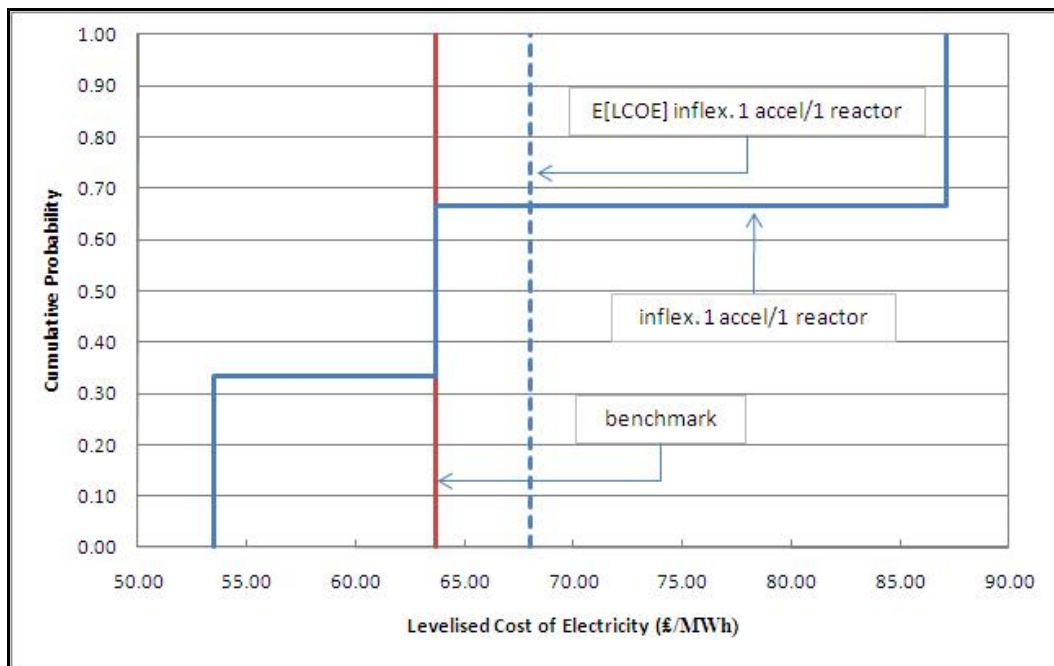

Figure 5: Target curves for the benchmark design with and without uncertainty recognition.

Step 3: Identifying Candidate Opportunities for Flexibility

Three major sources of flexibility are suggested to deal with uncertainty in ADSR effective availability, based on general flexible strategies in Trigeorgis (1996). The first is a strategic growth option “on” the system, expressed through the initial deployment phase for a first-of-a-kind demonstrator. This gives the “right but not the obligation” to expand to a demonstration reactor park if the accelerator reliability and technology is good enough. For this flexibility to be enabled, engineers should secure a site ahead of time so that additional ADSR systems can be added. This involves planning for sharing infrastructures in the case of expansion, choosing appropriate zoning, and setting all legal and financial aspects to enable expansion.

The second source of flexibility is an operational switching option “in” design. This flexibility is enabled by constructing a beam transport system such that all of the accelerators can direct their proton beam to any one of the reactors as required, at any given time. This creates an integrated reactor park with a single network of accelerators. This is useful when one of the reactors is down for scheduled maintenance. It provides the redundancy to switch to another accelerator if another experiences a scheduled or unscheduled shutdown.

The third source of flexibility is a strategic scale alteration option “in” design. It further enables the operational flexibility – or redundancy – just described. It is obtained by designing the system with contingency to add one more accelerator to increase effective availability in case it is too low due to frequent unscheduled shutdowns in the initial development phase. Other facets of the ADSR design are expected to have a significant, perhaps more significant, impact on its overall availability, such as if it is designed to operate as a fast reactor or is thorium fuelled. However, these challenges are wider reaching issues, affecting numerous nuclear reactor designs. Accelerator reliability is a unique challenge to ADSRs and has the potential to have a determining effect on the overall availability of ADSRs. Similar to the other strategic options, this may require securing a site for additional accelerator(s) and/or reactor(s), to potentially share infrastructures, and harmonize O&M schedules between accelerators and reactors.

The analysis presented in this paper focuses on the second and third sources of flexibility. These protect essentially from downside risks in power generation, in case technology does not perform as hoped. It is assumed that development moves on with a reactor park, which is why the first source of flexibility has not been considered in the quantitative analysis. Decision-makers may decide not to pursue this plan after the first-of-a-kind demonstrator phase, in which case the analysis in Steer et al. (2010) introduces some of the possible outcomes.

Step 4: Evaluation of Design Configurations

Decision-makers may choose between three strategies, as Figure 6 depicts in the decision tree.^v At the time of irreversible investment ($t = 0$), the first strategy is to select the upper branch and pursue the benchmark deployment in Figure 4. No adjustment is possible at the second decision node ($t = 8$ years). It assumes full commitment to the demonstration reactor park. The LCOE is dependent on how technological uncertainties unfold during the initial first-of-a-kind phase. This strategy is best if technology turns out better than expected, as in the optimistic case. It then makes sense to move on directly to a 3 accelerators/3 reactors configuration. It provides the lowest LCOE (£53.47/MWh) by saving the need for an additional accelerator. If the pessimistic scenario arises however, the plant becomes more costly (£87.15/MWh) as it does not have any means of exploiting redundancy to cope with deficient accelerator reliability.

All of the options for the two flexible strategies are shown together in Figure 7. The first flexible strategy (the second strategy overall) starts with a benchmark 1 accelerator/1 reactor configuration. It plans for the possibility of having a fourth accelerator in the second phase to exploit the operational flexibility to switch proton beams if effective availability is low. It does not, however, have the benefit of redundancy to switch accelerators in the first phase. The benefit is to save initially on additional capital expenditures, while risking producing less electricity in the first phase if effective availability is low. From there, managers

^v Sub-optimal decision branches are marked with a double hash in the dynamic programming – backward induction – phase of decision analysis. Branches with no hashing represent the best decision at a given decision node. The expected LCOE is shown under each branch at a decision point, in a square box. The recommended design is outlined in the box to the right and below the first, leftmost, decision point.

may choose to expand to either 4 accelerators/3 reactors or 3 accelerators/3 reactors configurations. In the optimistic scenario, the best decision is to expand to a 3 accelerators/3 reactors configuration, as expected. The LCOE (£53.78/MWh) is only slightly higher than for the inflexible case (£53.47/MWh) due to the cost of planning for a fourth accelerator in the initial phase, although it is not used. For the central and pessimistic scenarios, it is better to exploit the operational switching flexibility by adding an additional accelerator. The LCOE (£60.37/MWh and £64.99/MWh respectively) is lower than for the inflexible strategy in both cases (£63.66/MWh and £87.15/MWh respectively), essentially due to increased effective availability and higher electricity production.

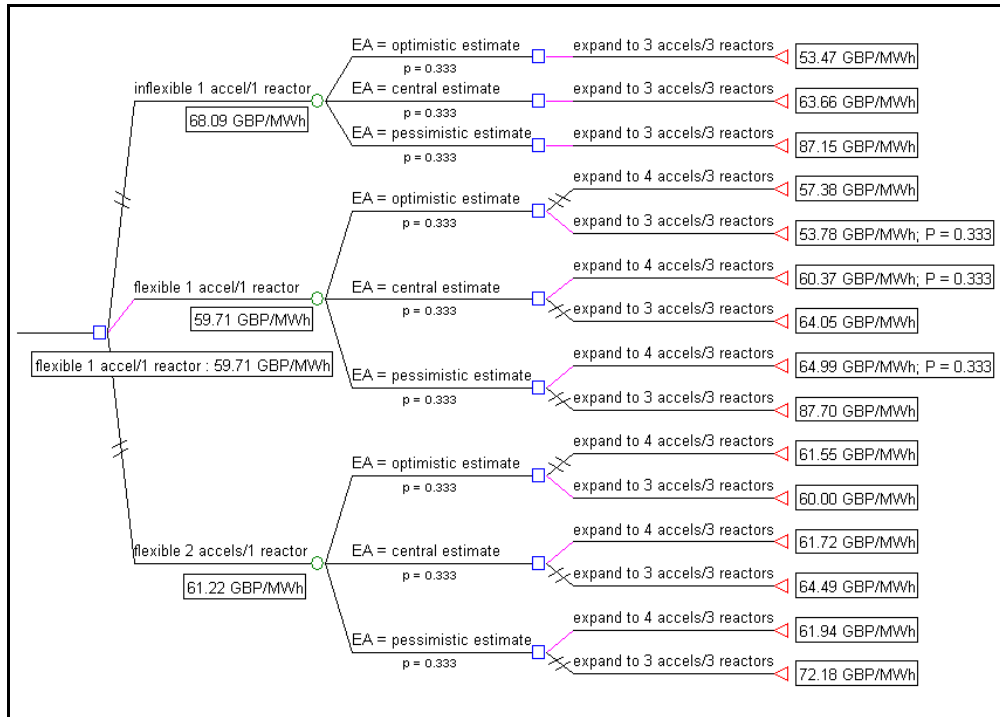

Figure 6: Decision tree for the real options analysis of a demonstration ADSR park.

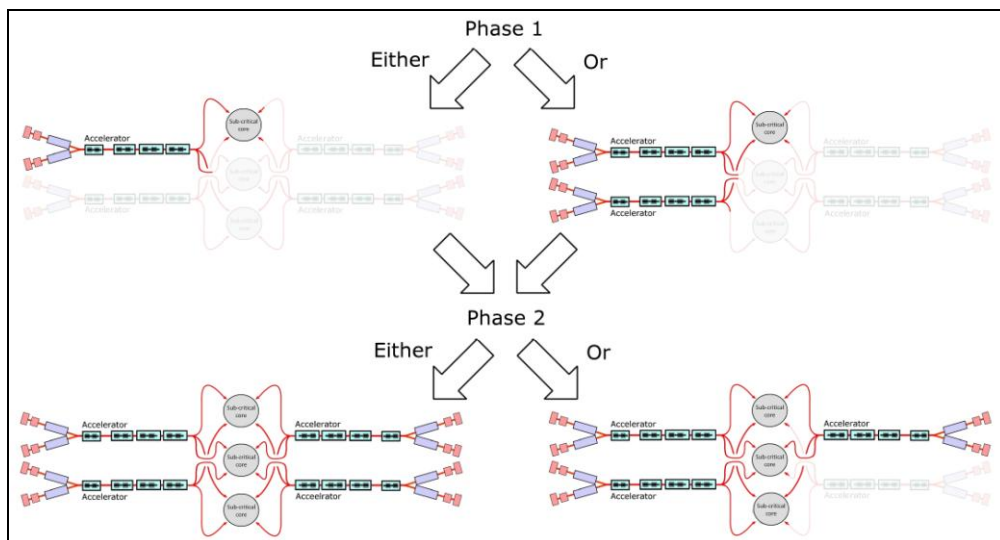

Figure 7: Conceptual representation of the two flexible strategies to deploying a demonstration ADSR park. The faintly coloured reactors, accelerators and beam transport systems are planned for, but not yet constructed.

The second flexible strategy (the third strategy overall), shown as the lower branch, exploits operational switching flexibility and requires an additional accelerator at the outset. This alternative also recognizes the strategic flexibility to expand to the most appropriate configuration depending on the effective availability scenario arising in the initial phase. It starts with a 2 accelerators/1 reactor design, and has the possibility to expand to either of the 4 accelerators/3 reactors or 3 accelerators/3 reactors configurations. Therefore, if the optimistic scenario arises, it is appropriate to construct only one more accelerator in addition to two reactors to reach a 3 accelerators/3 reactors configuration. The LCOE is £60.00/MWh, however, considerably higher than for the inflexible strategy under this scenario (£53.47/MWh). This is also more than for the flexible 1 accelerator/1 reactor configuration (£53.78/MWh), mainly due to the purchase of an unnecessary accelerator in the initial phase. If the central and pessimistic cases arise, it is better to expand to a 4 accelerators/3 reactors configuration. The extra electricity production provided by the additional accelerator outweighs the additional cost in these scenarios. For the central scenario, the LCOE (£61.72/MWh) is only slightly higher than for the flexible 1 accelerator/1 reactor configuration (£60.37/MWh) due to the early purchase of a redundant accelerator. The additional production capacity gives, however, a lower LCOE than for the inflexible case (£63.66/MWh). If the pessimistic scenario arises, the 2 accelerators/1 reactor configuration gives the best protection against downsides. It exploits the flexibility from the redundant accelerator in both development phases, which improves electricity production. The LCOE is £61.94/MWh compared to a high of £87.15/MWh for the inflexible, and £64.99/MWh for the flexible 1 accelerator/1 reactor design.

The recommended strategy depends on the utility of the decision-maker. For example, a risk-neutral decision-maker prefers a strategy minimizing the expected – or average – LCOE ($E[\text{LCOE}]$). This is the best metric for trading-off the chances of optimistic and pessimistic technology scenarios. It will not provide, however, the possibility of attaining the lowest absolute LCOE in the decision tree. As Figure 6 shows for the two flexible strategies, the lowest attainable LCOE is £53.78/MWh, as opposed to £53.47/MWh for the inflexible strategy. On the other hand, it also reduces the impact from a downside pessimistic scenario. The worst possible outcome is LCOE of £64.99/MWh, as opposed to the worst of all scenarios for the inflexible case (£87.15/MWh).

Thus, under the assumption of a uniform prior probability distribution (i.e. complete uncertainty), a risk-neutral decision-maker will prefer the flexible 1 accelerator/1 reactor design, with $E[\text{LCOE}] = £59.71/\text{MWh}$. The flexible 2 accelerators/1 reactor is not too far behind at $E[\text{LCOE}] = £61.22/\text{MWh}$. Both flexible strategies are noticeably better using this metric than for the inflexible strategy with $E[\text{LCOE}] = £68.09/\text{MWh}$. The decision to expand to a 3 or 4 accelerators/3 reactors demonstration park is based on how uncertainty is resolved during the first eight years of development.

The expected value of flexibility can be compared to the anticipated cost of the flexible first-of-a-kind demonstrator. This is the difference in $E[\text{LCOE}]$ between the inflexible and the best flexible strategies. As a rule of thumb, decision-makers

should not be willing to pay more than this value for the additional design and engineering cost, and requirements of a flexible park demonstrator. The cost of the additional accelerator (£290 million + interest) is already factored into the model. Comparing the flexible 1 accelerator/1 reactor to the inflexible design shows still positive expected value for the flexible strategy:

$$E[V_{flex.}] = E[LCOE_{inflex.}] - E[LCOE_{flex.}] = £68.09/MWh - £59.71/MWh = £8.38/MWh$$

Target curves in Figure 8 depict graphically the information in the decision tree for the 1 accelerator/1 reactor inflexible and flexible designs. They show that a strategy recognizing uncertainty and planning for appropriate flexibility in a 1 accelerator/1 reactor design provides much lower expected LCOE (dashed light vertical line) than in the initial deterministic assessment of step 1 (vertical solid line), and also compared to the stochastic but inflexible analysis of step 2 (vertical dark dashed line). They also show the probabilistic range of LCOE for the two deployment strategies (solid dark curve for inflexible; solid light curve for flexible). It is observed that $E[LCOE_{flex.}]$ is lower than for the inflexible case mainly because this strategy is better at protecting from downside risks in technology development (i.e. it avoids high LCOE outcomes from poor accelerator technology).

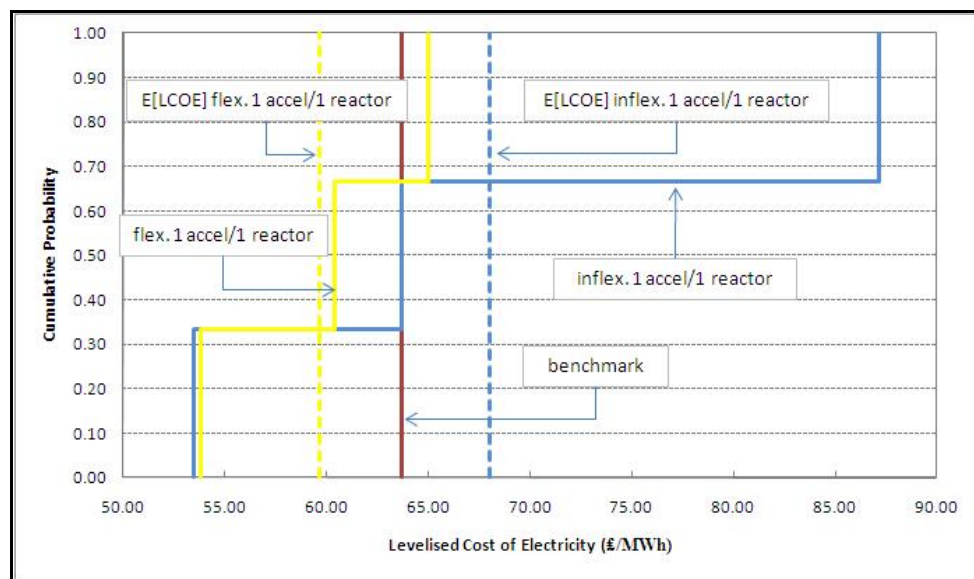

Figure 8: Target curves for inflexible and flexible 1 accelerator/1 reactor demonstration park deployment strategies.

a) Other Utility Metrics for Decision-Making

It is possible that $E[LCOE]$ is not the metric of choice for all decision-makers. Table 3 lists other metrics useful for decision-making, depending on the decision-maker's utility. For instance, a risk-averse individual might prefer a design minimizing initial capital expenditure, or reducing to the best extent possible the impact from a pessimistic technology scenario. Similarly, a risk-seeking decision-maker might choose a design giving the lowest possible LCOE, at the risk of obtaining the worst possible outcome – as in the inflexible design – if technology is poor and effective availability is low. The best strategy thus depends on the metric used, and the decision-maker's utility.

Table 3: Other metrics for evaluating alternative design strategies, with recommended decisions.

Metric	Benchmark (unrealistic)	Inflexible 1 accel./ 1 reactor	Flexible 1 accel./ 1 reactor	Flexible 2 accel./ 1 reactor	Which is best?
Initial capital expenditure (millions, £)	1,305	1,305	1,325	1,595	Inflexible
Maximum LCOE (£/MWh)	N/A	87.15	64.99	61.94	Flexible 2 accel./ 1 reactor
Minimum LCOE (£/MWh)	N/A	53.47	53.78	60.00	Inflexible

b) Sensitivity Analysis

The analysis above assumes a uniform probability among all three scenarios considered. Decision-makers might want to change these probability assignments, depending on information available at the time of decision-making. Alternatively they might be interested in the threshold probability assignments that trigger different decisions.

Figure 9 shows a sensitivity analysis on the probability assignments for scenarios 1, 2, and 3, using $E[LCOE]$ as the metric for decision-making. They show, in essence, that it is always better to go with the flexible approach, no matter what probability choice is made. Probability assignments may only affect the initial decision to go with a flexible 1 accelerator/1 reactor design versus a flexible 2 accelerators/1 reactor design.

The three-way sensitivity analysis varies probability assignments between 0 and 1 for the optimistic, central, and pessimistic scenarios, always making sure they sum to unity. It calculates the $E[LCOE]$ for each probability assignment, and shows which strategy is best between the inflexible design, and the two flexible strategies. This sensitivity analysis accounts for all possible assumptions about probability distributions (e.g. uniform, lognormal, normal, etc.). For example for the figure with $p(\text{central}) = 0.0$, it is preferable to choose a flexible design over almost all possible probability assignments for the optimistic and pessimistic scenarios. This is shown by the diagonal and square hash areas representing the best decisions at any given probability assignment. The flexible 1 accelerator/1 reactor is better than the flexible 2 accelerators/1 reactor design over a wider range of probabilities. There is a tiny, almost imperceptible area on the bottom right of the figure where $p(\text{central}) = 0.0$ where the best decision is to build inflexible. This area vanishes for $p(\text{central}) \geq 0.1$.

For brevity only examples with $p(\text{central}) = \{0.0; 0.1; 0.2\}$ are shown in Figure 9. All other sensitivity analyses where $p(\text{central}) > 0.2$ result in the flexible 1 accelerator/1 reactor strategy being preferable over a wider range of probability assignments as compared to the 2 accelerators/1 reactor flexible design.

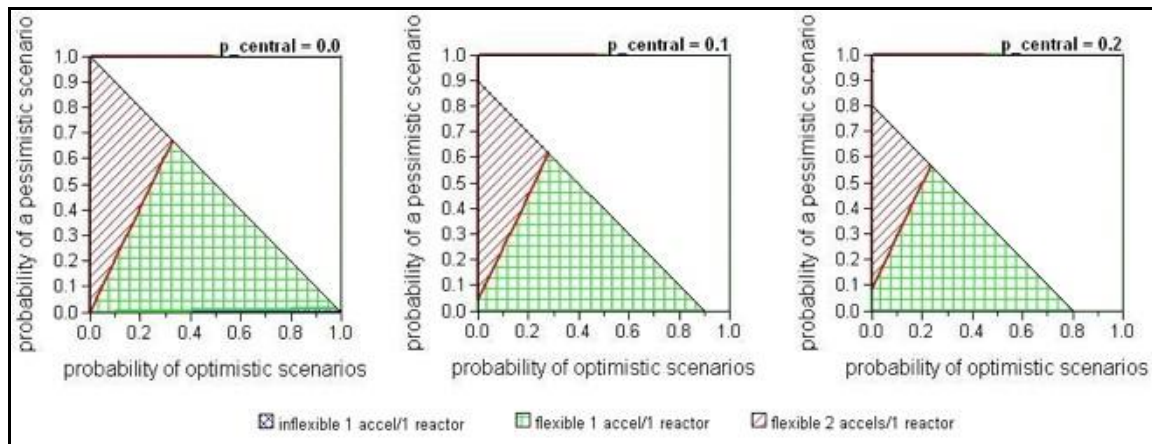

Figure 9: Sensitivity analysis over the probability assignments for scenarios 1, 2, and 3. For brevity, only cases with $p(\text{central}) = \{0.0; 0.1; 0.2\}$ are shown. For each value of $p(\text{central})$, light square hash areas correspond to probability combinations for optimistic and pessimistic scenarios where based on $E[\text{LCOE}]$ the flexible 1 accelerator/1 reactor strategy is favourable over the inflexible and flexible 2 accelerators/1 reactor strategies. Dark diagonal hash areas correspond to probability combinations where the flexible 2 accelerators/1 reactor strategy is preferable over the inflexible and flexible 1 accelerator/1 reactor designs. The inflexible design is preferable for only a tiny combination of probability assignments, hardly noticeable on the bottom right of the figure for $p(\text{central}) = 0.0$. Blank areas correspond to infeasible probability assignments resulting in a sum greater than unity.

▪ Discussion and Conclusion

This paper presents an integrated methodology to analyze the deployment cost of a new and promising nuclear technology subject to technological uncertainty, through a case example of a demonstration commercial thorium-fuelled ADSR park. The analysis shows that considering explicitly technological uncertainty and flexibility in the early conceptual design phase can reduce significantly the expected deployment LCOE ($E[\text{LCOE}]$). Under the model assumptions described in Table 1 and Steer et al. (2010), and the assumption of complete uncertainty about how effective availability will evolve in the first-of-a-kind phase (i.e. uniform prior probability distribution), the analysis shows a 12% reduction in expected LCOE for developing a demonstration reactor park as compared to an inflexible strategy. This is not negligible for such multi-billion pound project. This expected value cost reduction should be compared to the real acquisition cost of the flexibility. If the acquisition cost is lower than its expected value, decision-makers should benefit from it.

Although other analytical tools can be used to value flexibility, there are many reasons motivating the use of decision analysis in this paper. For instance, one cannot assume that a portfolio of tradable assets exists to replicate the future cash flows of the first-of-a-kind ADSR park demonstrators. This rules out the risk-neutrality and arbitrage-enforced pricing assumptions that are used in classical real options methods (e.g. Cox et al., 1979; Dixit and Pindyck, 1994; Trigeorgis, 1996). Decision analysis is useful when an engineering project exhibits considerable path dependencies, suggesting a binomial lattice analysis (e.g. based on the work of Arnold and Crack, 2003; Cox et al., 1979) may not be appropriate in this case. It provides better transparency to decision-makers, and

enables relative rank ordering of different design choices based on approximate value rather than fair, economically rigorous market price. This greater transparency and ease of use comes at the expense of less economic rigor and the inability to analyze many uncertainty sources and stages. The complexity of rigorous economic real options analysis is, however, quoted as a deterrent against wider use in real-world practice (Barman and Nash, 2007; Engel and Browning, 2008).

One downside from decision analysis relates to the choice of a probability distribution, for which data may not always be available. To circumvent this, a sensitivity analysis over all possible distributions is presented in Figure 9. It shows that flexibility is favourable under almost all cases, almost independent of the assumed probability distribution.

The flexibilities elicited suggest a new design approach to demonstrating the deployment of an ADSR park. This approach differs from the typical ADSR design considering only one reactor and one accelerator. Providing contingencies for an additional accelerator gives additional flexibility from a strategic standpoint (i.e. the ability to add one accelerator if technology is less favourable than originally planned, but good enough to provide sufficient capacity). From an operational standpoint, this additional accelerator can reduce operational stress compared to a design where only one accelerator is used by enabling switching redundancy between the two.

One limitation is that only one uncertainty source is considered here for simplicity, even though many more exist in reality. As a further step, a simulation-based screening model can be developed to account for more uncertainty sources, scenarios, and details in technology modelling, based on the work by Lin (2009), Wang (2005), and Yang (2009). The assessment can also be extended to include the possibility of driving ADSRs with multiple compact accelerators, such as non-scaling Fixed-Field Alternating Gradient (ns-FFAG) accelerators, synchrotrons or superconducting cyclotrons.

In conclusion, this paper highlights the importance of considering uncertainty and flexibility in the early conceptual design of new technological development, as opposed to later in the detailed design phase. Recognizing the additional value from flexibility – in terms of saved costs – may provide better support from a policy standpoint for public investment in R&D of such capital intensive, risky, but promising technological ventures. It should be clear that this methodology differs from sensitivity analysis because it incorporates decision-makers' capacity to adapt to various situations along the development path. This assessment is more realistic than a typical DCF approach that does not recognize flexibility, and hence may result in overestimating the expected cost of the technological venture.

▪ **Acknowledgements**

The authors would like to thank gratefully the UK Engineering and Physical Sciences Research Council (EPSRC), the Electricity and Policy Research Group at the University of Cambridge, the National Science and Engineering Research

Council of Canada, the MIT Portugal Program, and MIT Engineering Systems Division for their financial support. This work is supported, in part, by the EPSRC under grant EP/G009864/1.

▪ References

Abdelhamid, M.-B., Aloui, C., Chaton, C. (2009), "A Real Options Approach to Investing in the First Nuclear Power Plant Under Cost Uncertainty: Comparison with Natural Gas Power Plant for the Tunisian Case", *International Journal of Oil, 2, 1*, pp. 44-57.

Arnold, T., Crack, T. (2003), "Option Pricing in the Real World: A Generalized Binomial Model with Applications to Real Options", Working Paper, University of Richmond, Department of Finance. Available at <http://www.ssrn.com>

Babajide, A., de Neufville, R., Cardin, M.-A. (2009), "Integrated Method for Designing Valuable Flexibility in Oil Development Projects", *SPE Projects, Facilities & Construction, 4, 2*, pp. 3-12.

Barman, B., Nash, K. (2007), "A Streamlined Real Options Model for Real Estate Development", Joint Master of Science Thesis in Real Estate Development, Massachusetts Institute of Technology, Cambridge, MA, USA.

Biarrotte, J.-L. (2007), "Status of the EUROTRANS R&D Activities for ADS Accelerator Development", *Utilisation and Reliability of High Power Proton Accelerators (HPPA5) Workshop*, Mol, Belgium.

Bowman, C.D., Arthur, E.D., Lisowski, P.W., Lawrence, G.P., Jensen, R.J., Anderson, J.L., Blind, B., Cappiello, M., Davidson, J.W., England, T.R., Engel, L.N., Haight, R.C., Hughes, H.G. III, Ireland, J.R., Krakowski, R.A., LaBauve, R.J., Letellier, B.C., Perry, R.T., Russell, G.J., Staudhammer, K.P., Versamis, G., Wilson, W.B. (1992), "Nuclear-Energy Generation and Waste Transmutation using an Accelerator-Driven Intense Thermal-Neutron Source", *Nuclear Instruments and Methods in Physics Research, Section A, 320*, pp. 336-367.

Cardin, M.-A., Kolschoten, G., Frey, D., de Neufville, R. (2010), "Quantitative Experimental Evaluation of a Design Procedure Enabling Flexibility in Engineering Systems", to be submitted to *Research in Engineering Design*.

Carminati, F., Klapisch, R., Revol, J.P., Roche, C., Rubio, J.A., Rubbia, C. (1993), "An Energy Amplifier for Cleaner and Inexhaustible Nuclear Energy Production Driven by a Particle Beam Accelerator", CERN/AT/93-47 (ET), European Organization for Nuclear Research.

Cox, J.C., Ross, S.A., Rubenstein, M. (1979), "Options Pricing: A Simplified Approach", *Journal of Financial Economics, 7, 3*, pp. 229-263.

Deutch, J., Moniz, E., Ansolabehere, S., Driscoll, M., Gray, P.E., Holdren, J.P., Joskow, P.L., Lester, R.K., Todreas, N.E. (2003), *The Future of Nuclear Power: An*

Interdisciplinary MIT Study, Massachusetts Institute of Technology, Cambridge, MA, USA. Available at <http://web.mit.edu/nuclearpower/>

de Neufville, R., Scholtes, S. (2010), *Flexibility in Design*, in press, MIT Press, Cambridge, MA, USA.

de Neufville, R., Odoni, A. R. (2003), *Airport Systems Planning and Management*, McGraw-Hill.

de Weck, O., de Neufville, R., Chaize, M. (2004), "Staged Deployment of Communication Satellite Constellation in Low Earth Orbit", *Journal of Aerospace Computing, Information, and Communications*, 1, 3, pp. 119-131.

Dixit, A. K., Pindyck, R.S. (1994), *Investment under Uncertainty*, Princeton University Press, Princeton, NJ, USA.

Dong, Q. (2002), "Predicting and Managing System Interactions at Early Phase of the Product Development Process", Doctoral Dissertation in Mechanical Engineering, Massachusetts Institute of Technology, MA, USA.

Engel, A., Browning, T.R. (2008), "Designing Systems for Adaptability by Means of Architecture Options", *Systems Engineering*, 11, 2, pp. 125-146.

Foster, J., Lee, B. (2009), "Sophisticated Sensitivity: Can Developers Guess Smarter?", Master of Science Joint Master of Science Thesis in Real Estate Development, Massachusetts Institute of Technology, Cambridge, MA, USA.

Foster, D.G. (Ed.) (1974), "Review of PNL Study on Transmutation Processing of High Level Waste", LA-UR, Los Alamos Scientific Laboratory.

Jablonowski, C., Wiboonkij-Arphakul, C., Neuhold, M. (2008), "Estimating the Cost of Errors in Estimates Used During Concept Selection", *SPE Projects, Facilities & Construction*, 3, 1, pp. 1-6.

Kennedy, D. (2007), "New Nuclear Power Generation in the UK: Cost Benefit Analysis", *Energy Policy*, 35, pp. 3701-3716.

Kiryama, E., Suzuki, A. (2004), "Use of Real Options in Nuclear Power Plant Valuation in the Presence of Uncertainty with CO2 Emission Credit", *Journal of Nuclear Science and Technology*, 41, 7, pp. 756-764.

Kwakkel, J., Walker, W.E., Marchau, V. (2010), "Assessing the Efficacy of Adaptive Airport Strategic Planning: Results from Computational Experiments", submitted to *Transport Policy*.

Lin, J. (2009), "Exploring Flexible Strategies in Engineering Systems Using Screening Models – Applications to Offshore Petroleum Projects", Doctoral Dissertation in Engineering Systems, Massachusetts Institute of Technology, MA, USA.

Loubergé, H., Villeneuve, S., Chesney, M. (2002), "Long-Term Risk Management of Nuclear Waste: A Real Options Approach", *Journal of Economic Dynamics and Control*, 27, pp. 157-180.

Luehrman, T. (1998), "Investment Opportunities as Real Options: Getting Started on the Numbers", *Harvard Business Review*, July-August, pp. 3-15.

Marreco, J., Carpio, L.G.T. (2006), "Flexibility Valuation in the Brazilian Power System: A Real Options Approach", *Energy Policy*, 34, pp. 3749-3756.

Moen, J. (2010), "Nuclear Power", U.S. Energy Information Administration, Independent Statistics and Analysis,
<http://www.eia.doe.gov/cneaf/nuclear/page/analysis/nuclearpower.html>

Morgan, M.G., Henrion, M. (1990), *Uncertainty: A Guide to Dealing with Uncertainty in Quantitative Risk and Policy Analysis*, Cambridge University Press, Cambridge, UK.

Myers, S.C. (1977), "Determinants of Corporate Borrowing", *Journal of Financial Economics*, 5, pp. 147-175.

Nuclear Energy Agency (NEA) (2000), "Reduction of Capital Costs of Nuclear Power Plants", OECD, Paris, France.

Pindyck, R.S. (2000), "Irreversibilities and the Timing of Environmental Policy", *Resource Energy Economics*, 22, pp. 233-259.

Pindyck, R.S. (1993), "Investments of Uncertain Cost", *Journal of Financial Economics*, 34, 1, pp. 53-76.

Pouret, L., Buttery, N. and Nuttall, W.J. (2009), "Is Nuclear Power Flexible?" *Nuclear Future*, 5, 6, pp.333-341.

Rothwell, G. (2006), "A Real Options Approach to Evaluating New Nuclear Power Plants", *The Energy Journal*, 1, 27, pp. 37-53.

Rubbia, C., Rubio, J.A., Buono, S., Carminati, F., Fiétier, N., Galvez, J., Gelès, C., Kadi, Y., Klapisch, R., Mandrillon, P., Revol, J.P., Roche, C. (1995), "Conceptual Design of a Fast Neutron Operated High Power Energy Amplifier", CERN/AT/95-44 (ET), European Organization for Nuclear Research.

Savage, S. (2000), "The Flaw of Averages", *San Jose Mercury News*, October 8.

Siddiqui, A., Fleten, S.E. (2008), "How to Proceed with Competing Alternative Energy Technologies: A Real Options Analysis", *Munich Personal RePEc Archive*, Paper No. 15502.

Siddiqui, A., Fleten, S.E. (2008), "How to Proceed with the Thorium Nuclear Technology: A Real Options Analysis", Research Report No. 297, Department of Statistical Science, University College London. Available at <http://www.ucl.ac.uk/Stats/research/reports/psfiles/rr297.pdf>

Silver, M.R., de Weck, O.L. (2007), "Time-Expanded Decision Networks: A Framework for Designing Evolvable Complex Systems", *Systems Engineering*, 10, 2, pp. 167-186.

Steer, S.J., Nuttall, W.J., Parks, G.T., Gonçalves, L.V.N. (2009), "Predicting the Contractual Cost of Unplanned Shutdowns of Power Stations: An Accelerator-Driven Subcritical Reactor Case Study", submitted to *Electric Power Systems Research. Electricity and Policy Research Group Working Paper EPRG0927*, University of Cambridge. Available at: <http://www.eprg.group.cam.ac.uk/category/publications/working-paper-series/2009/>

Steer, S.J., Cardin, M.-A., Nuttall, W.J., Parks, G.T., Gonçalves, L.V.N. (2010), "Hedging Against Technology Risks of the Accelerator System of a First-of-a-Kind Accelerator-Driven Subcritical Reactor", *Electricity and Policy Research Group Working Paper EPRG1013*, University of Cambridge. Available at: <http://www.eprg.group.cam.ac.uk/category/publications/working-paper-series/>

Taneja, P., Walker, W.E., Ligteringen, H., van Schuylenburg, M. (2010), "Adaptive Port Planning using Real Options", International Association of Maritime Economists, CARGO Edições, Lda.

Trigeorgis, L. (1996), *Real Options*, MIT Press, Cambridge, MA, USA.

University of Chicago (2004), "The Economic Future of Nuclear Power – A Study Conducted at the University of Chicago", Chicago, IL, USA. Available at <http://www.world-nuclear.org/reference/pdf/uoc-study.pdf>

Walker, W.E., Rahman, S.A., Cave, J. (2001), "Adaptive Policies, Policy Analysis, and Policy-Making", *European Journal of Operational Research*, 128, pp. 282-289.

Wang, T. (2005), "Real Options in Projects and Systems Design – Identification of Options and Solutions for Path Dependency", Doctoral Dissertation in Engineering Systems, Massachusetts Institute of Technology, MA, USA.

World Nuclear Association (2009), "Nuclear Power in the United Kingdom", accessed on August 17, 2009. Available at <http://www.world-nuclear.org/info/inf84.html>

Yang, Y. (2009), "A Screening Model to Explore Planning Decisions in Automotive Manufacturing Systems Under Demand Uncertainty", Doctoral Dissertation in Engineering Systems, Massachusetts Institute of Technology, MA, USA.